

Data Sheet

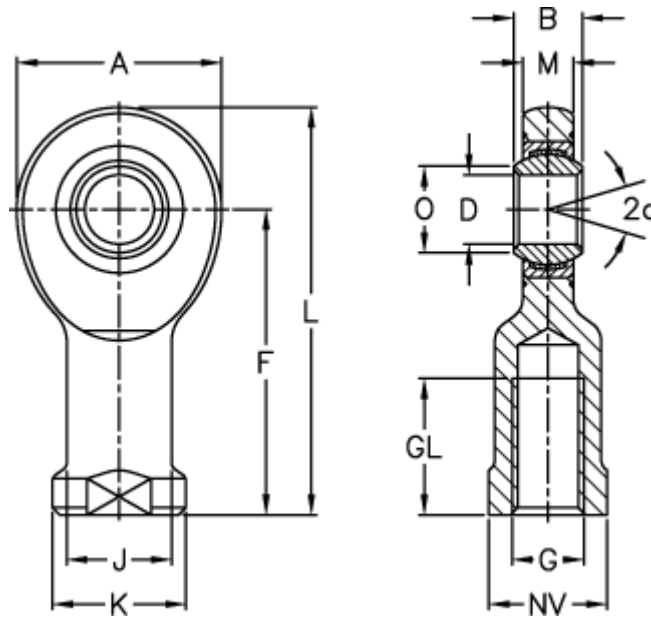

Article number: 03484010
Description: Fluro Rod end EIL 10D
Note: 10

Measures



A	= 28	J	= 15
a (degrees)	= 12	K	= 19
B	= 9	L	= 57
D	= 10	M	= 7
Dynamic drive (kN)	= 8.6	NV	= 17
F	= 43	O	= 13.2
g	= M10	Static drive kN	= 23.4
GL	= 20	Weight	= 60